



### Features:

- ◆ 1: 4CT Impedance
- ◆ 75Ω Characteristic Impedance
- ◆ Frequency: 1 to 350 MHz
- ◆ RF power: 0.50W
- ◆ DC current: 30mA
- ◆ Operating temperature range: -40°C to +85°C
- ◆ Storage temperature range: -55°C to +100°C



### Applications:

- ◆ For broadband and wireless communications
- ◆ For VHF/UHF receivers/transmitters and push-pull amplifiers

### Dimension Diagram (Unit:mm) :

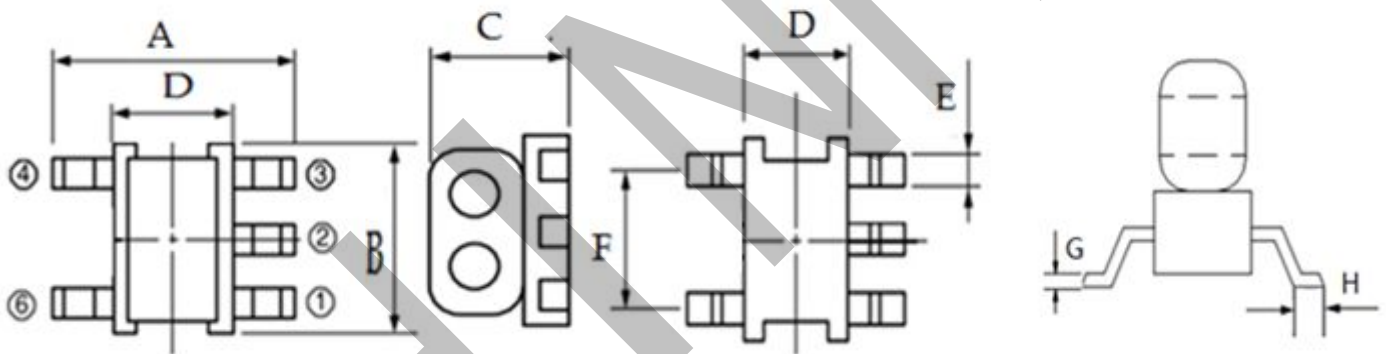

A=4.10±0.20 B=3.80±0.20 C=3.20±0.20 D=2.80±0.20 E=0.55±0.05 F=2.54±0.05 G=0.25±0.05 H=0.60±0.05

### Electrical structure:

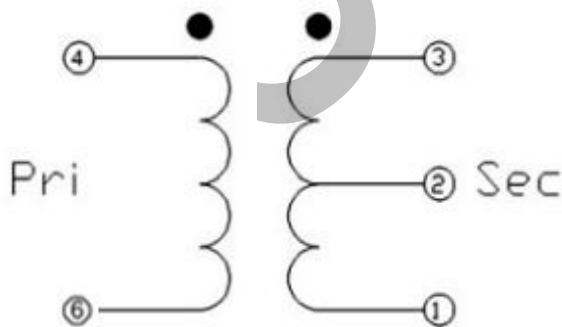

Schematic

### Recommended layout:

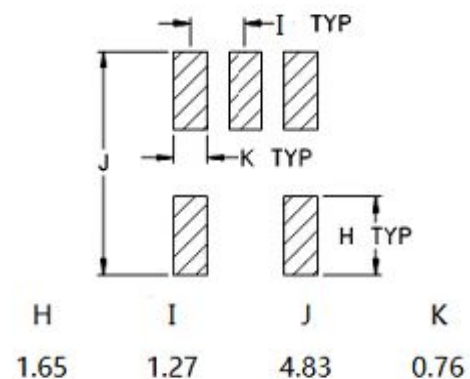

## Pin configuration

Pin no.	Function
1	Secondary (Output 2)
2	Centre tap (Ground)
3	Secondary dot (Output 1)
4	Primary dot (Input)
6	Primary (Ground)

## Application circuit :

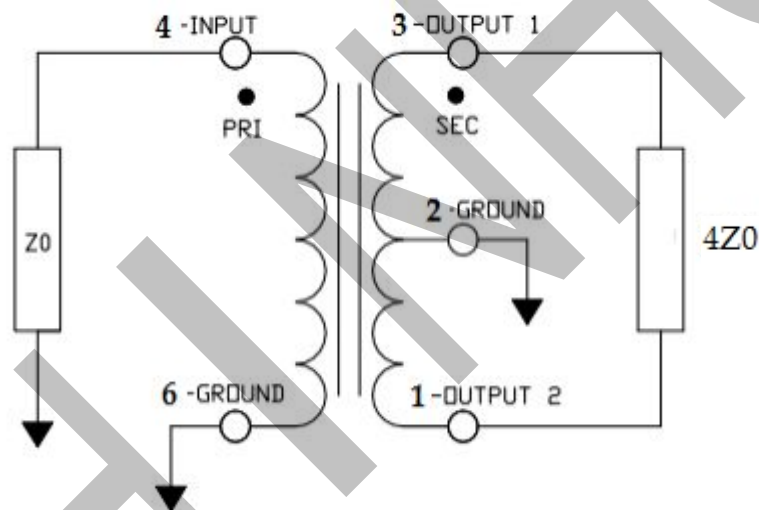

Electrical Specifications:  $T_A = 25^\circ\text{C}$   $Z_0 = 75\Omega$

Parameter	Test Conditions	Units	Min	Typ	Max
Main line Loss(out1)	1-350MHz	dB	—	0.8	1.5
Main line Loss(out2)	1-350MHz	dB	—	0.7	1.5
Amplitude Balance	1-350MHz	dB	—	0.3	$\pm 0.5$
Phase Balance	1-350MHz	Degrees	—	$\pm 1$	$\pm 5.0$
Input Return Loss	1-350MHz	dB	6.0	16.0	—

### Main line Loss(out1)

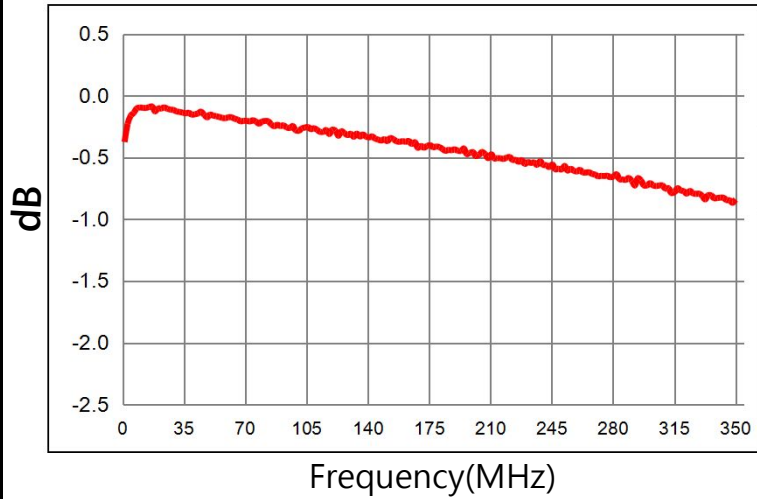

### Main line Loss(out2)

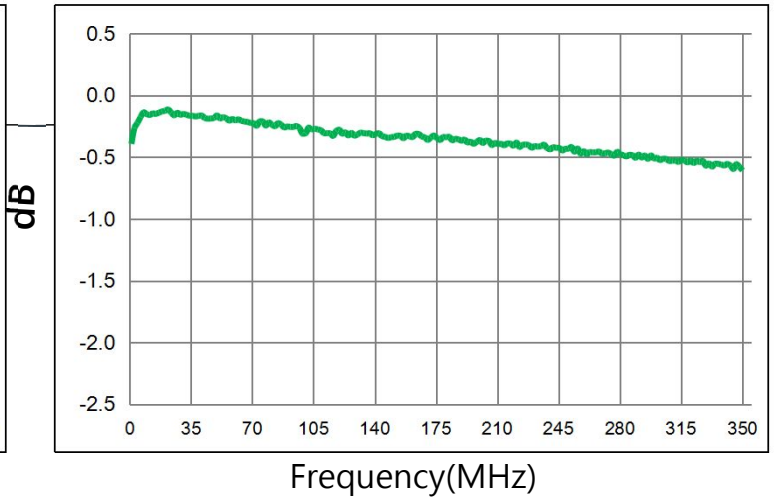

### Amplitude Balance

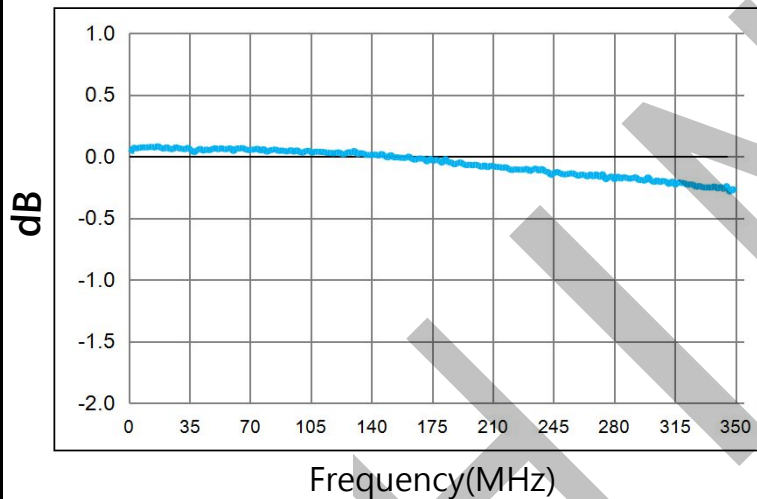

### Phase Balance

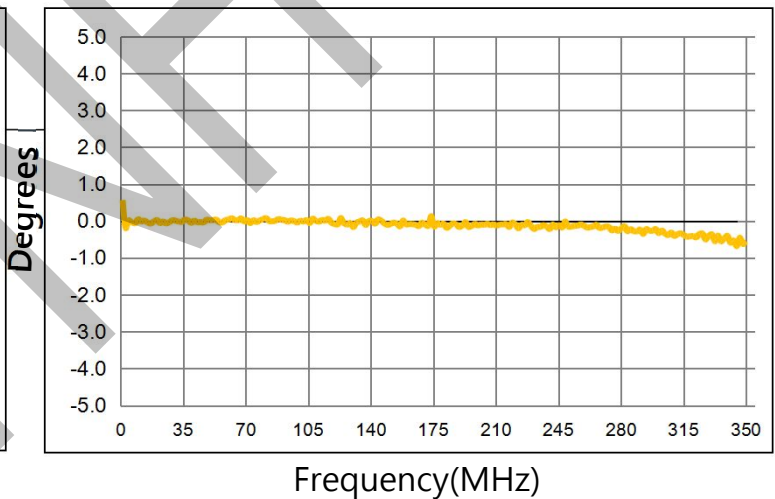

### Input Return Loss

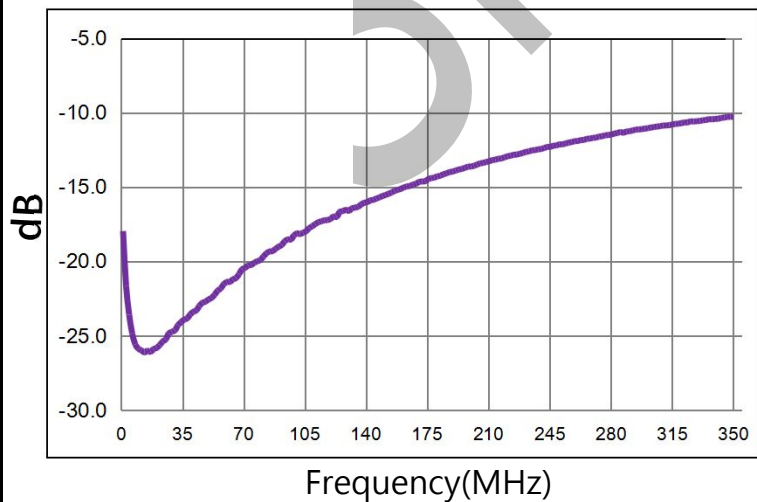

### Sdd22

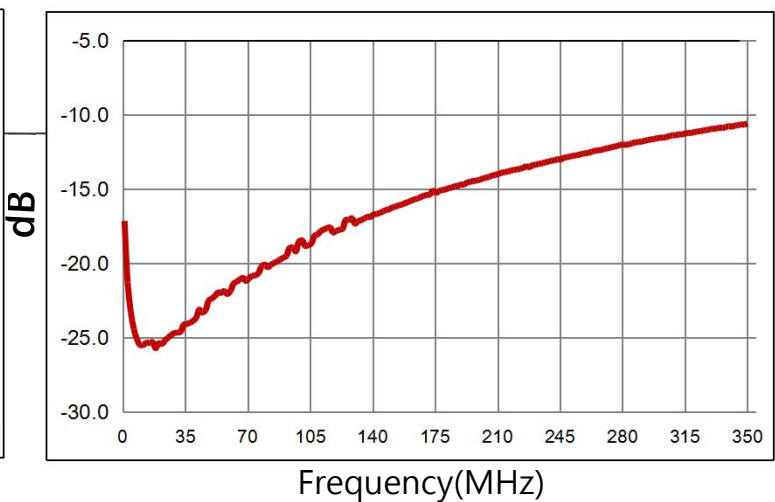

**Recommended Soldering Temperature Graph:**

建议迴焊条件  
The condltion of reflow  
(Recommendation)

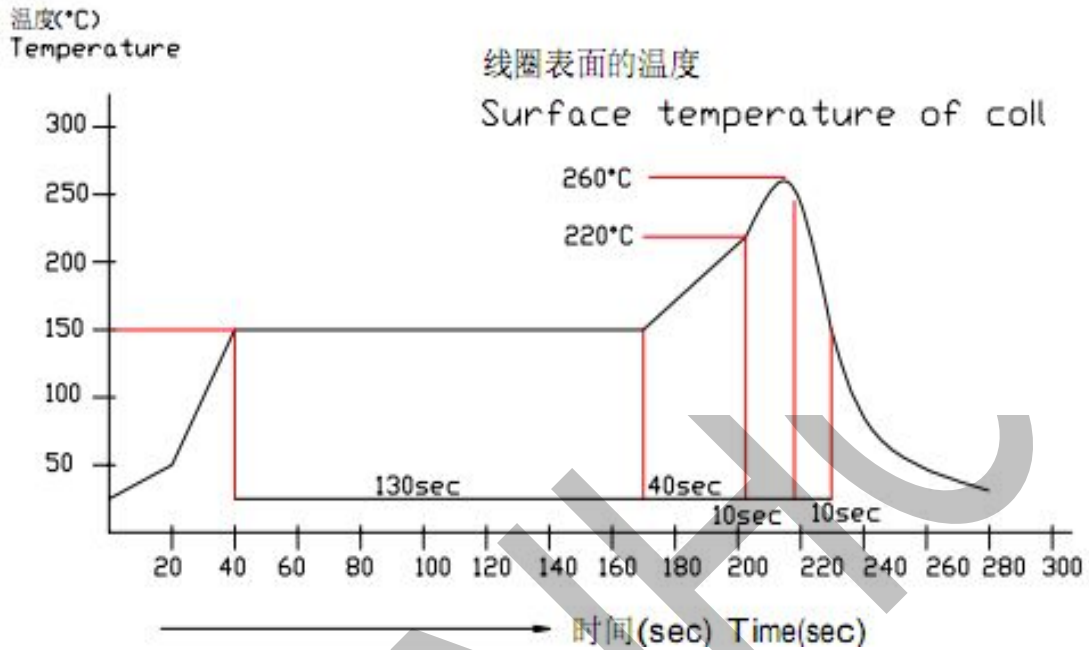

**Packing Dimension For Caeier Tape(UNIT:mm):**

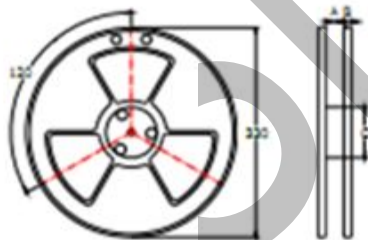
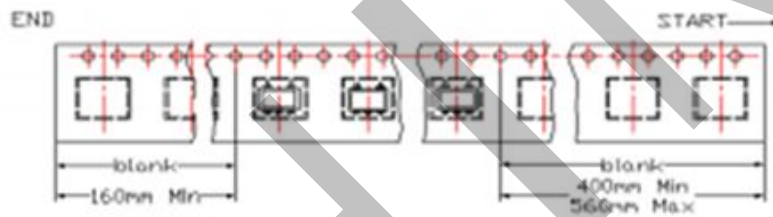

SPEC	8	12	16	24	32	44	56	72
DIM A±0.1	8.5	12.5	16.5	24.5	32.5	44.5	56.5	72.5
DIM B±0.1	2.3	2.3	2.3	2.3	2.3	2.3	2.3	2.3
DIM Ct0.1	100	100	100	100	100	100	100	100

**QUANTITY**

2000PCS/Reel

15 reel/Big carton/60000pcs